

**PowerMOS transistor  
Logic level TOPFET**

**BUK112-50GL**

**DESCRIPTION**

Monolithic temperature and overload protected logic level power MOSFET in a 5 pin plastic envelope, intended as a low side switch for automotive applications.

**QUICK REFERENCE DATA**

SYMBOL	PARAMETER	MAX.	UNIT
$V_{DS}$	Continuous drain source voltage	50	V
$I_D$	Continuous drain current	12	A
$T_j$	Continuous junction temperature	150	°C
$R_{DS(ON)}$	Drain-source on-state resistance	93	mΩ
SYMBOL	PARAMETER	NOM.	UNIT
$V_{PS}$	Protection supply voltage	5	V

**FEATURES**

- Vertical power DMOS output stage
- Low on-state resistance
- Low operating supply current
- Overtemperature protection
- Overload protection against short circuit load with drain current limiting
- Latched overload protection reset by protection supply
- Protection circuit condition indicated by flag pin
- Off-state detection of open circuit load indicated by flag pin
- 5 V logic compatible input level
- Integral input resistors.
- ESD protection on all pins
- Over voltage clamping

**FUNCTIONAL BLOCK DIAGRAM**

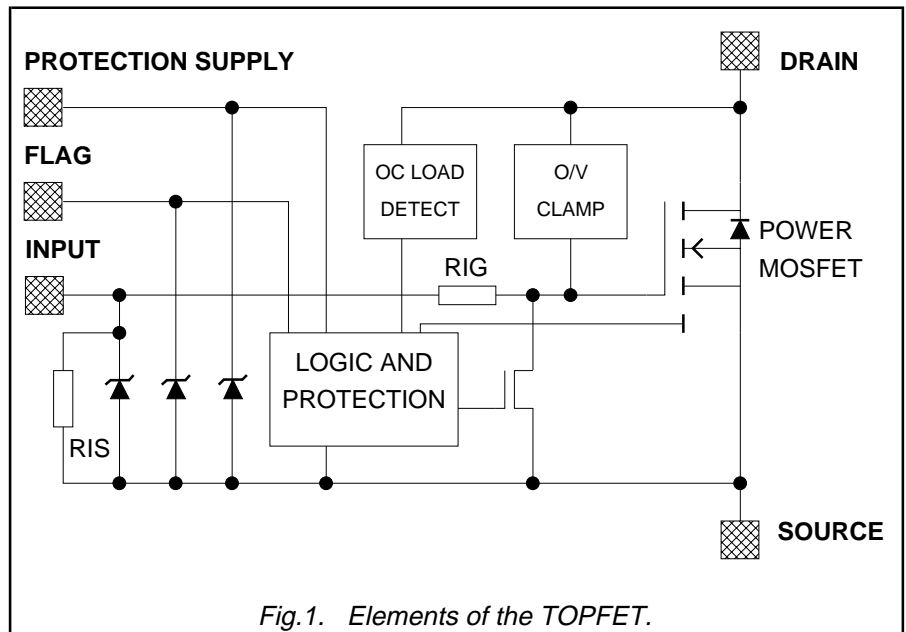

**PINNING - SOT263**

PIN	DESCRIPTION
1	input
2	flag
3	drain
4	protection supply
5	source
tab	drain

**PIN CONFIGURATION**

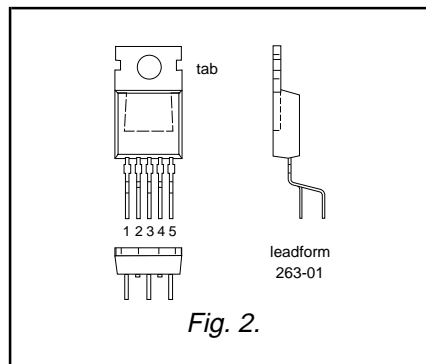

**SYMBOL**

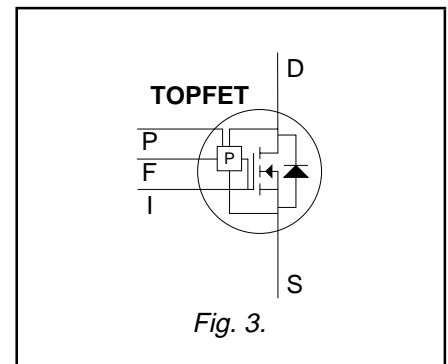

# PowerMOS transistor

## Logic level TOPFET

BUK112-50GL

### LIMITING VALUES

Limiting values in accordance with the Absolute Maximum Rating System (IEC 134)

SYMBOL	PARAMETER	CONDITIONS	MIN.	MAX.	UNIT
$V_{DS}$	<b>Continuous voltage</b> Drain source voltage <sup>1</sup>	$V_{IS} = 0 \text{ V}$	-	50	V
$I_D$	<b>Continuous currents</b> Drain current	$V_{PS} = 5 \text{ V}; T_{mb} = 25 \text{ }^\circ\text{C}$	-	self - limited	A
$I_i$	Input current	$V_{PS} = 0 \text{ V}; T_{mb} = 94 \text{ }^\circ\text{C}$	-	12	A
$I_F$	Flag current	-	-5	5	mA
$I_P$	Protection supply current	-	-5	5	mA
$P_{tot}$	<b>Thermal</b> Total power dissipation	$T_{mb} = 25 \text{ }^\circ\text{C}$	-	52	W
$T_{stg}$	Storage temperature	-	-55	175	$^\circ\text{C}$
$T_j$	Junction temperature <sup>2</sup>	continuous	-	150	$^\circ\text{C}$
$T_{sold}$	Lead temperature	during soldering	-	260	$^\circ\text{C}$

### ESD LIMITING VALUES

SYMBOL	PARAMETER	CONDITIONS	MIN.	MAX.	UNIT
$V_{C1}$	<b>Electrostatic discharge capacitor voltages</b> Drain to source	Human body model; $C = 100 \text{ pF}; R = 1.5 \text{ k}\Omega$	-	4.5	kV
$V_{C2}$	Input, flag or protection to source		-	2	kV

### OVERLOAD PROTECTION LIMITING VALUE

With the protection supply connected, TOPFET can protect itself from two types of overload - short circuit load and overtemperature.

For overload conditions an n-MOS transistor turns on between the gate and source to quickly discharge the power MOSFET gate capacitance.

The drain current is limited to reduce dissipation in case of short circuit load. Refer to OVERLOAD CHARACTERISTICS.

SYMBOL	PARAMETER	CONDITIONS	MIN.	MAX.	UNIT
$V_{PSP}$	Protection supply voltage <sup>3</sup>	for valid protection	4.5	-	V

### OVERVOLTAGE CLAMPING LIMITING VALUES

At a drain source voltage above 50 V the power MOSFET is actively turned on to clamp overvoltage transients.

SYMBOL	PARAMETER	CONDITIONS	MIN.	MAX.	UNIT
$E_{DSM}$	Non-repetitive clamping energy	$I_{DM} = 6 \text{ A}; T_{mb} = 25 \text{ }^\circ\text{C}$	-	200	mJ
$E_{DRM}$	Repetitive clamping energy	$I_{DM} = 3.1 \text{ A}; V_{DD} \leq 20 \text{ V};$ $T_{mb} \leq 120 \text{ }^\circ\text{C}; f = 250 \text{ Hz}$	-	20	mJ

<sup>1</sup> Prior to the onset of overvoltage clamping. For voltages above this value, safe operation is limited by the overvoltage clamping energy.

<sup>2</sup> A higher  $T_j$  is allowed as an overload condition but at the threshold  $T_{j(TO)}$  the over temperature trip operates to protect the switch.

<sup>3</sup> The minimum supply voltage required for correct operation of the overload protection circuits.

**PowerMOS transistor**  
**Logic level TOPFET**

BUK112-50GL

**THERMAL CHARACTERISTICS**

SYMBOL	PARAMETER	CONDITIONS	MIN.	TYP.	MAX.	UNIT
$R_{th\ j-mb}$ $R_{th\ j-a}$	<b>Thermal resistance</b>					
	Junction to mounting base	-	-	-	2.38	K/W
	Junction to ambient	in free air	-	60	-	K/W

**OUTPUT CHARACTERISTICS** $T_{mb} = 25\text{ }^{\circ}\text{C}$ ;  $V_{PS} = 0\text{ V}$  unless otherwise specified

SYMBOL	PARAMETER	CONDITIONS	MIN.	TYP.	MAX.	UNIT
$V_{(CL)DSS}$	<b>Off-state</b> Drain-source clamping voltage	$I_D = 10\text{ mA}$ ; $-40\text{ }^{\circ}\text{C} \leq T_{mb} \leq 150\text{ }^{\circ}\text{C}$	50	-	70	V
		$I_{DM} = 0.75\text{ A}$ ; $t_p \leq 300\text{ }\mu\text{s}$ ; $\delta \leq 0.01$	50	60	70	V
$I_{DSS}$	Drain-source leakage current <sup>1</sup>	$V_{IS} = 0\text{ V}$ ; $V_{DS} = 13\text{ V}$	-	0.5	10	$\mu\text{A}$
		$V_{DS} = 50\text{ V}$	-	1	20	$\mu\text{A}$
		$T_{mb} = 125\text{ }^{\circ}\text{C}$ ; $V_{DS} = 40\text{ V}$	-	10	100	$\mu\text{A}$
$R_{DS(ON)}$	<b>On-state</b> Drain-source on-resistance	$t_p \leq 300\text{ }\mu\text{s}$ ; $\delta \leq 0.01$	-	70	93	$\text{m}\Omega$
		$I_{DM} = 6\text{ A}$ ; $V_{IS} = 4.4\text{ V}$ ; $V_{PS} = 4.5\text{ V}$ $T_{mb} = 150\text{ }^{\circ}\text{C}$	-	135	165	$\text{m}\Omega$

**INPUT CHARACTERISTICS** $T_{mb} = 25\text{ }^{\circ}\text{C}$  unless otherwise specified

SYMBOL	PARAMETER	CONDITIONS	MIN.	TYP.	MAX.	UNIT
$V_{IS(TO)}$	<b>Normal operation</b> Input threshold voltage	$V_{DS} = 13\text{ V}$ ; $V_{PS} = 0\text{ V}$ ; $I_D = 1\text{ mA}$ $-40\text{ }^{\circ}\text{C} \leq T_{mb} \leq 150\text{ }^{\circ}\text{C}$	1	1.5	2	V
			0.5	-	2.5	V
$I_{IS}$	Input current	$V_{IS} = 5\text{ V}$ $-40\text{ }^{\circ}\text{C} \leq T_{mb} \leq 150\text{ }^{\circ}\text{C}$	200	350	500	$\mu\text{A}$
$V_{(CL)IS}$	Input clamping voltage	$I_I = 1.5\text{ mA}$	6	7.1	-	V
$R_{IG}$	Internal series resistance	to gate of power MOSFET	-	1.5	-	$\text{k}\Omega$
$I_{ISL}$	<b>Overload protection latched</b> Input current					
		$V_{PS} = 5\text{ V}$ ; $V_{IS} = 5\text{ V}$	1.5	3.2	4	$\text{mA}$

**REVERSE CHARACTERISTICS** $T_{mb} = 25\text{ }^{\circ}\text{C}$ 

SYMBOL	PARAMETER	CONDITIONS	MIN.	TYP.	MAX.	UNIT
$-V_{DS}$	Reverse drain voltage <sup>2</sup>	$-I_D = 6\text{ A}$	-	0.8	-	V
$-V_{IS}$	Reverse input voltage	$-I_I = 5\text{ mA}$	-	0.7	-	V
$-V_{PS}$	Reverse protection pin voltage	$-I_P = 5\text{ mA}$	-	0.7	-	V
$-V_{FS}$	Reverse flag voltage	$-I_F = 5\text{ mA}$	-	0.7	-	V

1 The drain current required for open circuit load detection is switched off when there is no protection supply, in order to ensure a low off-state quiescent current. Refer to OPEN CIRCUIT LOAD DETECTION CHARACTERISTICS.

2 Protection functions are disabled during reverse conduction.

# PowerMOS transistor Logic level TOPFET

## BUK112-50GL

### PROTECTION SUPPLY CHARACTERISTICS

$T_{mb} = 25\text{ °C}$  unless otherwise specified

SYMBOL	PARAMETER	CONDITIONS	MIN.	TYP.	MAX.	UNIT
$I_{PS}, I_{PSL}$	Normal operation or protection latched Supply current	$V_{PS} = 4.5\text{ V}$ $-40\text{ °C} \leq T_{mb} \leq 150\text{ °C}$	-	330	400	$\mu\text{A}$
			-	-	450	$\mu\text{A}$
$V_{(CL)PS}$	Clamping voltage	$I_P = 1.5\text{ mA}$	6	7.1	-	V
$V_{PSR}$	Overload protection latched Reset voltage	$-40\text{ °C} \leq T_{mb} \leq 150\text{ °C}$	-	2.1	-	V
			1.5	-	3	V
$t_{pr}$	Reset time	$V_{PS} = 0\text{ V}$ $-40\text{ °C} \leq T_{mb} \leq 150\text{ °C}$	-	25	-	$\mu\text{s}$
			-	-	150	$\mu\text{s}$

### OPEN CIRCUIT LOAD DETECTION CHARACTERISTICS

An open circuit load condition can be detected while the TOPFET is in the off-state.  
 $-40\text{ °C} \leq T_{mb} \leq 150\text{ °C}$ ;  $V_{PS} = 5\text{ V}$ ;  $V_{DS} = 13\text{ V}$  unless otherwise specified

SYMBOL	PARAMETER	CONDITIONS	MIN.	TYP.	MAX.	UNIT
$I_{DSP}$	Off-state drain current <sup>1</sup>	$V_{IS} = 0\text{ V}$	0.5	1.4	2	mA
$I_{DSF}$	Off-state drain threshold current	$V_{IS} = 0\text{ V}$ ; $I_F = 100\text{ }\mu\text{A}$	0.4	1.1	-	mA
$V_{ISF}$	Input threshold voltage <sup>2</sup>	$I_F = 100\text{ }\mu\text{A}$ ; $I_D = 100\text{ }\mu\text{A}$ ; $T_{mb} = 25\text{ °C}$	-	1.2	-	V

### TRUTH TABLE

For normal, open-circuit load and overload conditions or inadequate protection supply voltage.

CONDITION	PROTECTION	INPUT	FLAG	OUTPUT
Normal on-state	1	1	0	1
Normal off-state	1	0	0	0
Open circuit load	1	1	0	1
Open circuit load	1	0	1	0
Short circuit load	1	1	1	0
Over temperature	1	X	1	0
Low protection supply voltage	0	1	1	1
Low protection supply voltage	0	0	1	0

For protection '0' equals low, '1' equals high.  
For input '0' equals low, '1' equals high, 'X' equals don't care.  
For flag '0' equals low, '1' equals open or high.  
For output switch '0' equals off, '1' equals on.

<sup>1</sup> The drain source current which flows when the protection supply is high and the input is low.

<sup>2</sup> For open circuit load indication,  $V_{IS}$  must be less than  $V_{ISF}$ .

# PowerMOS transistor

## Logic level TOPFET

BUK112-50GL

### OVERLOAD CHARACTERISTICS

 $T_{mb} = 25\text{ }^{\circ}\text{C}$ ;  $V_{PS} = 5\text{ V}$  unless otherwise specified

SYMBOL	PARAMETER	CONDITIONS	MIN.	TYP.	MAX.	UNIT
$I_D$	<b>Short circuit load protection</b>					
	Drain current limiting	$V_{IS} = 5\text{ V}$ $V_{DS} = 13\text{ V}$ $-40\text{ }^{\circ}\text{C} \leq T_{mb} \leq 150\text{ }^{\circ}\text{C}$	12	24	36	A
	Overload power threshold <sup>1</sup>	for protection to operate	-	100	-	W
	Characteristic energy	which determines trip time <sup>2</sup>	-	200	-	mJ
$I_{DM}$	Peak drain current <sup>3</sup>	$V_{DD} = 13\text{ V}$ ; $R_L \leq 10\text{ m}\Omega$	-	45	-	A
$T_{j(TO)}$	<b>Overtemperature protection</b>					
Threshold temperature		$I_D \geq 1\text{ A}$	150	185	215	$^{\circ}\text{C}$

### FLAG CHARACTERISTICS

The flag is an open drain transistor which requires an external pull-up circuit.

 $T_{mb} = 25\text{ }^{\circ}\text{C}$  unless otherwise specified

SYMBOL	PARAMETER	CONDITIONS	MIN.	TYP.	MAX.	UNIT
$V_{FSF}$	<b>Flag 'low'</b> Flag voltage	normal operation; $V_{PS} = 5\text{ V}$ $I_F = 100\text{ }\mu\text{A}$	-	0.7	-	V
		$-40\text{ }^{\circ}\text{C} \leq T_{mb} \leq 150\text{ }^{\circ}\text{C}$	-	-	0.9	V
$I_{FSF}$	Flag saturation current	$V_{FS} = 5\text{ V}$	-	10	-	mA
$I_{FSO}$	<b>Flag 'high'</b> Flag leakage current	overload or fault $V_{FS} = 5\text{ V}$	-	0.1	1	$\mu\text{A}$
		$T_{mb} = 150\text{ }^{\circ}\text{C}$	-	1	10	$\mu\text{A}$
$V_{(CL)FS}$	Flag clamping voltage	$I_F = 100\text{ }\mu\text{A}$	6	6.9	-	V
$V_{PSF}$	Protection supply threshold voltage <sup>4</sup>	$I_F = 100\text{ }\mu\text{A}$ ; $V_{DS} = 5\text{ V}$	2.5	3	4	V
		$-40\text{ }^{\circ}\text{C} \leq T_{mb} \leq 150\text{ }^{\circ}\text{C}$	2	-	4	V
$R_F$	<b>Application information</b>					
	Suitable external pull-up resistance	$V_{FF} = 5\text{ V}$	-	50	-	k $\Omega$

1 Refer to figure 15.

2 Trip time  $t_{dsc} \approx E_{DSC} / [P_D - P_{D(TO)}]$ . Refer also to figure 15.

3 For short circuit load connected after turn-on.

4 When  $V_{PS}$  is less than  $V_{PSF}$  the flag pin indicates low protection supply voltage. Refer to TRUTH TABLE.

---

PowerMOS transistor  
Logic level TOPFET

---

BUK112-50GL

**SWITCHING CHARACTERISTICS** $T_{mb} = 25\text{ }^{\circ}\text{C}$ 

SYMBOL	PARAMETER	CONDITIONS	MIN.	TYP.	MAX.	UNIT
	<b>Resistive load</b>	$R_L = 4\ \Omega$ ; $I_D = 3\ \text{A}$				
$t_{d\ on}$	Turn-on delay time	$V_{IS}: 0\ \text{V} \Rightarrow 5\ \text{V}$	-	0.6	-	$\mu\text{s}$
$t_r$	Rise time		-	2.8	-	$\mu\text{s}$
$t_{d\ off}$	Turn-off delay time	$V_{IS}: 5\ \text{V} \Rightarrow 0\ \text{V}$	-	3.5	-	$\mu\text{s}$
$t_f$	Fall time		-	3.2	-	$\mu\text{s}$
	<b>Inductive load</b>	$I_D = 3\ \text{A}$ ; $V_{DD} = 13\ \text{V}$ ; with freewheel diode				
$t_{d\ on}$	Turn-on delay time	$V_{IS}: 0\ \text{V} \Rightarrow 5\ \text{V}$	-	0.9	-	$\mu\text{s}$
$t_r$	Rise time		-	1.2	-	$\mu\text{s}$
$t_{d\ off}$	Turn-off delay time	$V_{IS}: 5\ \text{V} \Rightarrow 0\ \text{V}$	-	6.7	-	$\mu\text{s}$
$t_f$	Fall time		-	0.6	-	$\mu\text{s}$

PowerMOS transistor  
Logic level TOPFET

BUK112-50GL

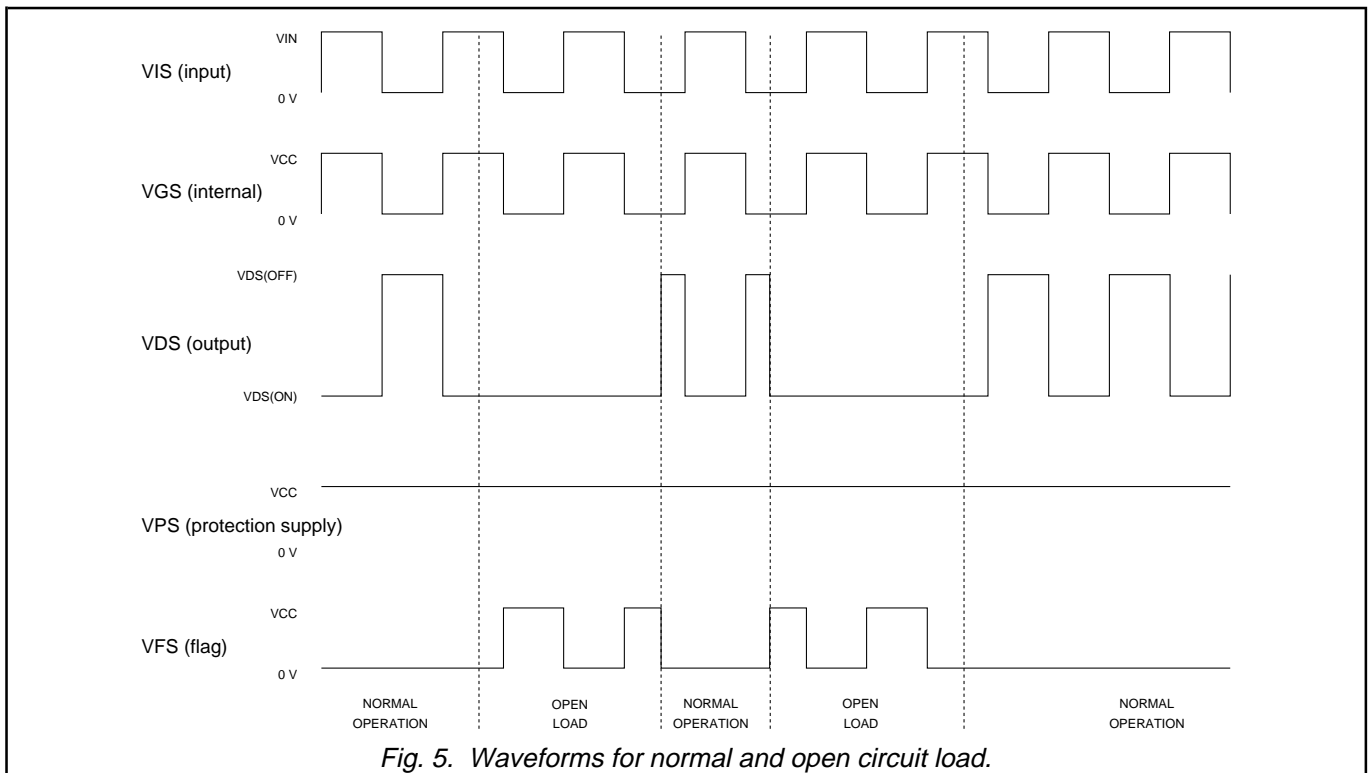
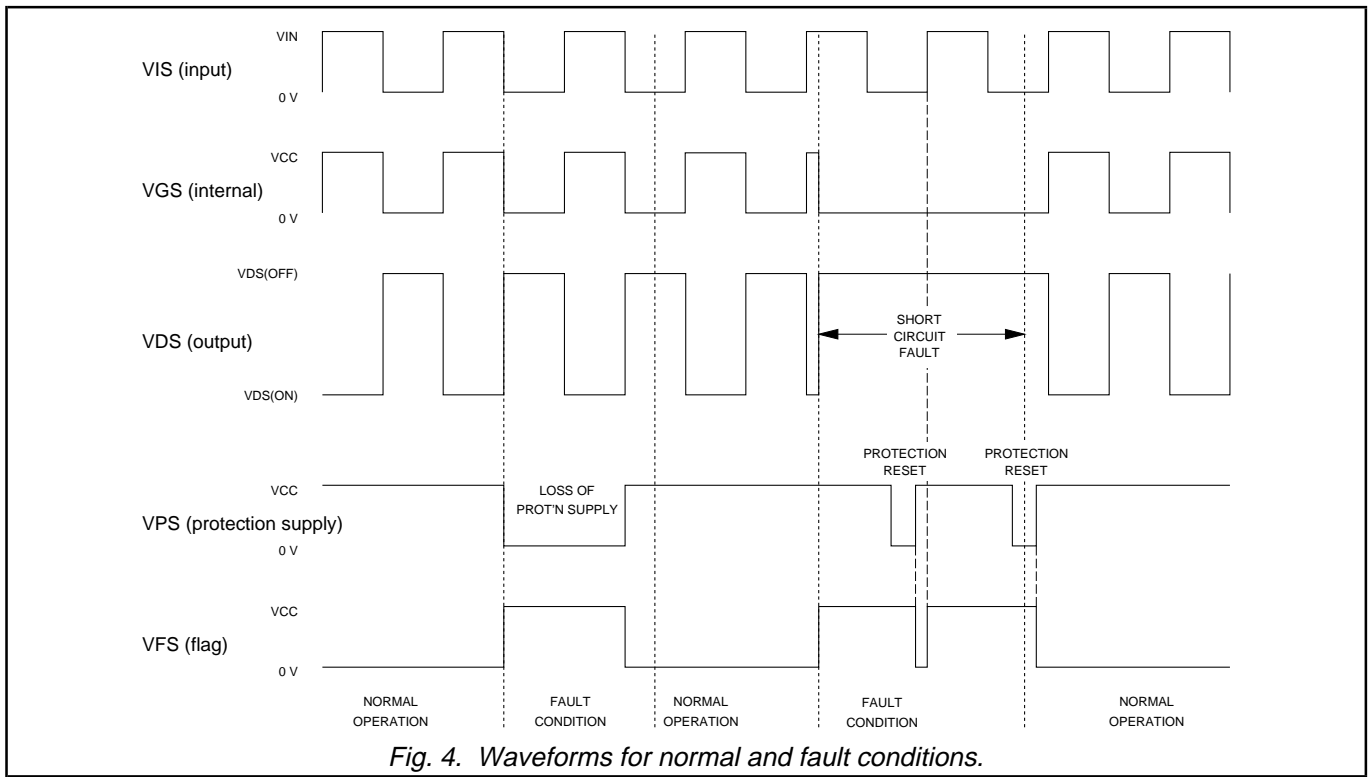

PowerMOS transistor  
Logic level TOPFET

BUK112-50GL

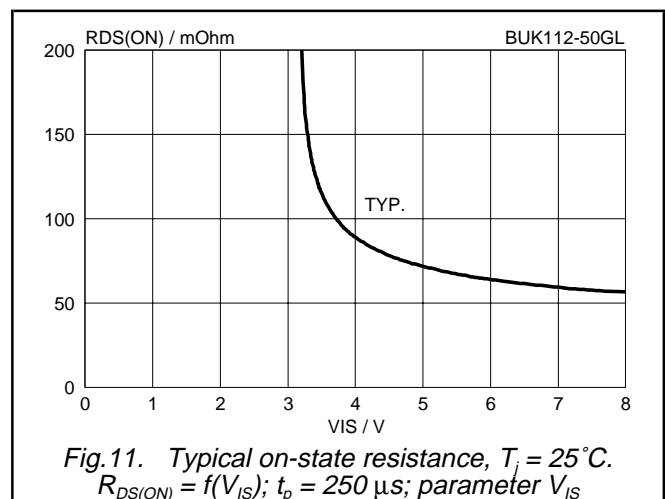
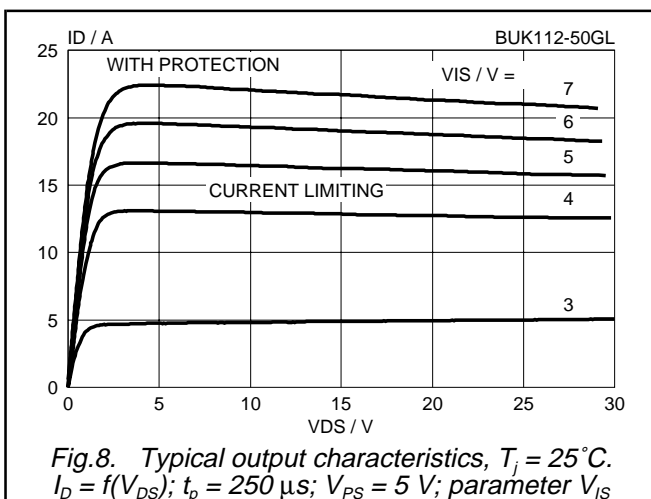
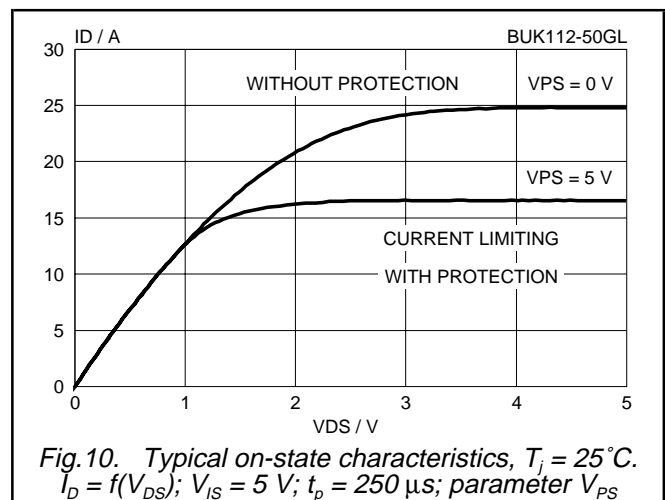
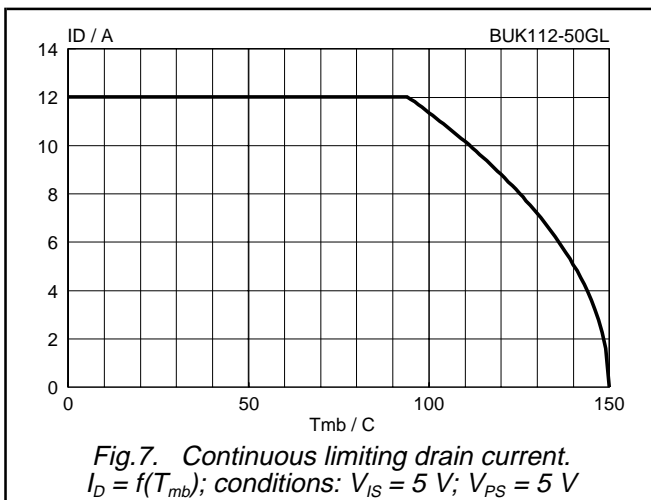
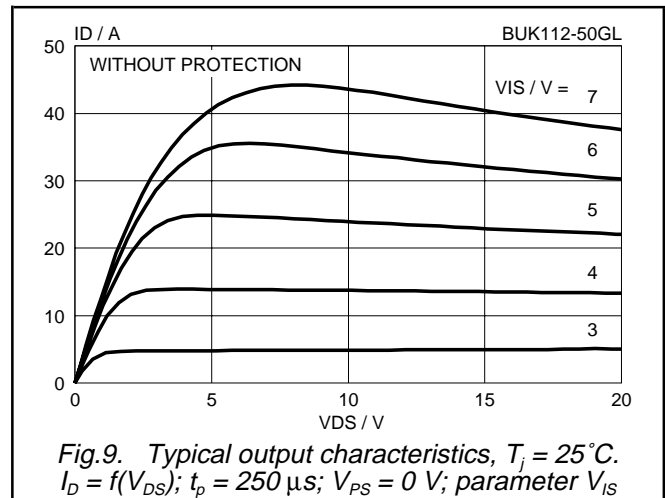
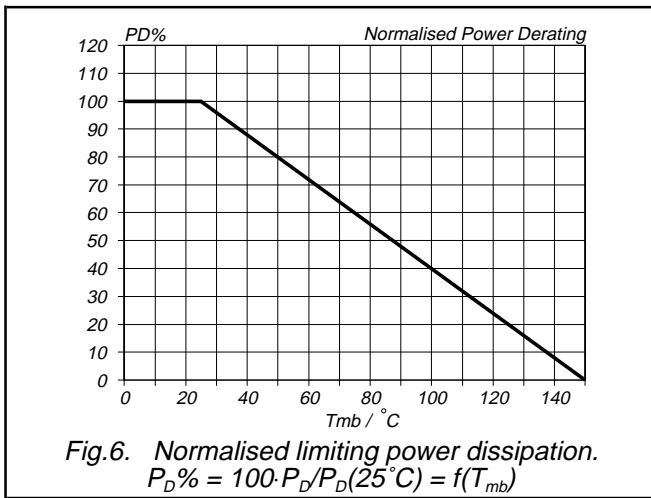



PowerMOS transistor  
Logic level TOPFET

BUK112-50GL

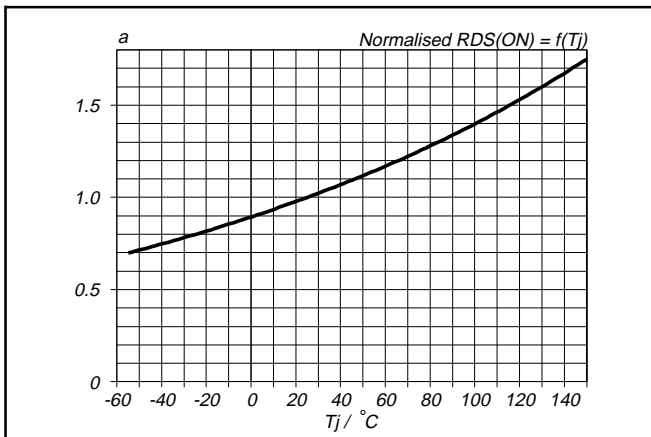

Fig.12. Normalised drain-source on-state resistance.  
 $a = R_{DS(ON)}/R_{DS(ON)25^{\circ}C} = f(T_j)$ ;  $I_D = 6\text{ A}$ ;  $V_{IS} \geq 4.4\text{ V}$

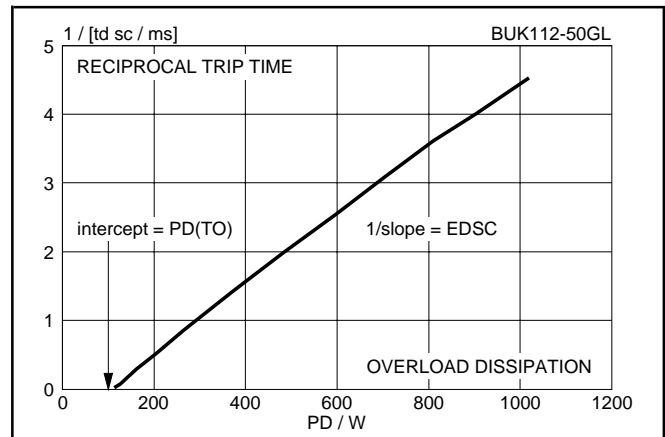

Fig.15. Typical reciprocal overload trip time.  
 $1/t_{dsc} = f(P_D)$ ; conditions:  $V_{PS} = 5\text{ V}$ ,  $T_{mb} = 25^{\circ}C$

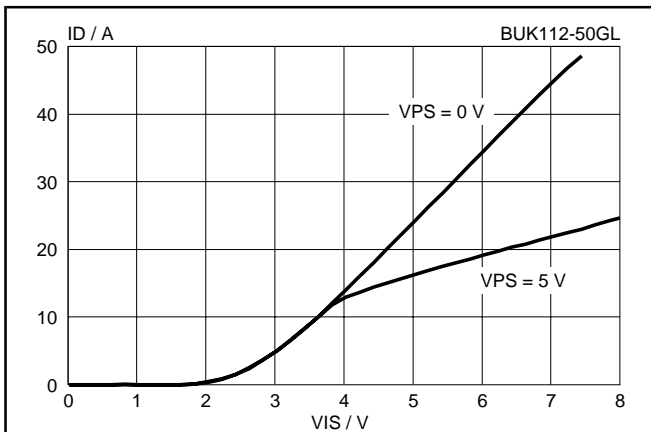

Fig.13. Typical transfer characteristics,  $T_j = 25^{\circ}C$ .  
 $I_D = f(V_{IS})$ ; conditions:  $V_{DS} = 10\text{ V}$ ;  $t_p = 250\text{ }\mu\text{s}$

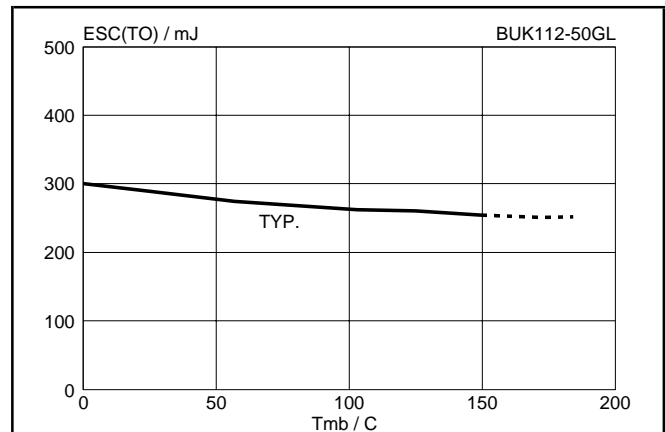

Fig.16. Typical overload protection energy.  
 $E_{SC(TO)} = f(T_{mb})$ ;  $V_{DD} = 13\text{ V}$ ;  $V_{PS} = 5\text{ V}$ ,  $V_{IS} = 5\text{ V}$

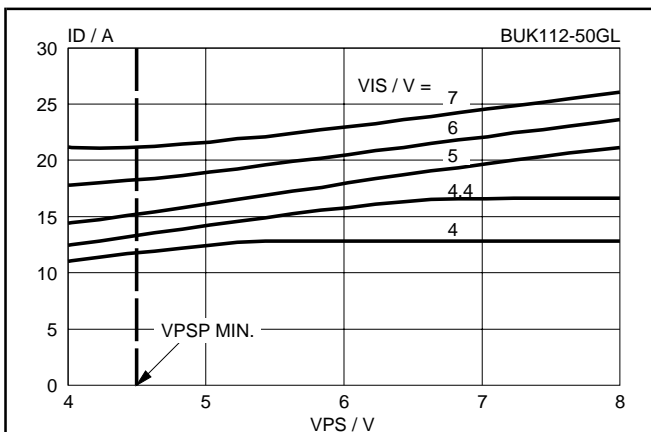

Fig.14. Typical output current limiting,  $T_j = 25^{\circ}C$ .  
 $I_D = f(V_{PS})$ ;  $t_p = 250\text{ }\mu\text{s}$ ;  $V_{DS} = 10\text{ V}$ ; parameter  $V_{IS}$

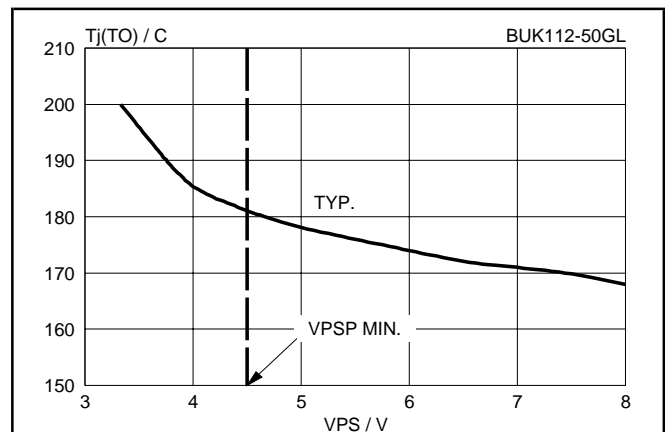
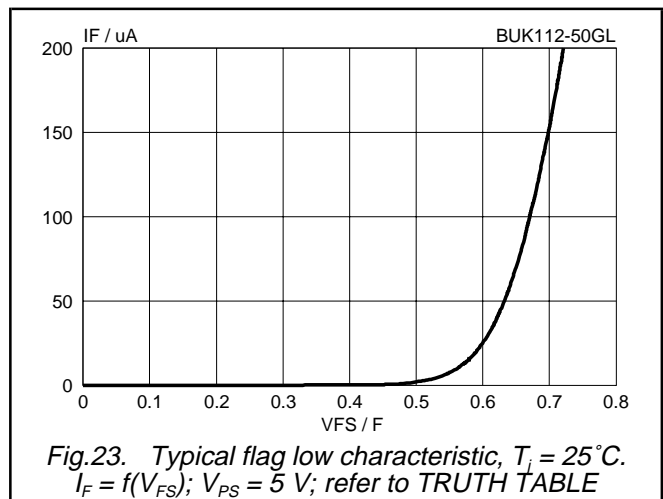
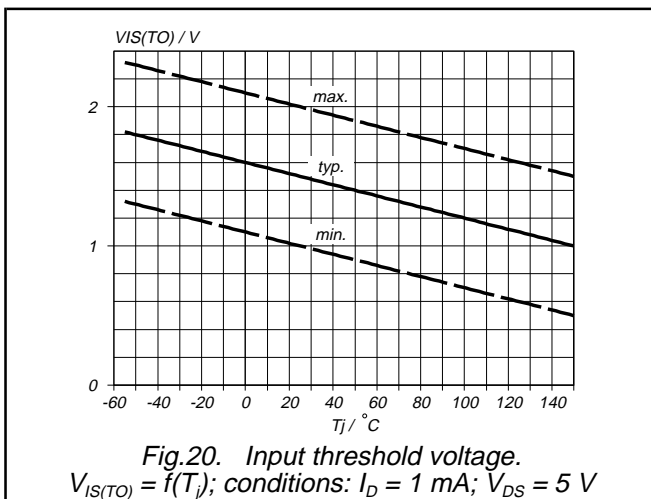
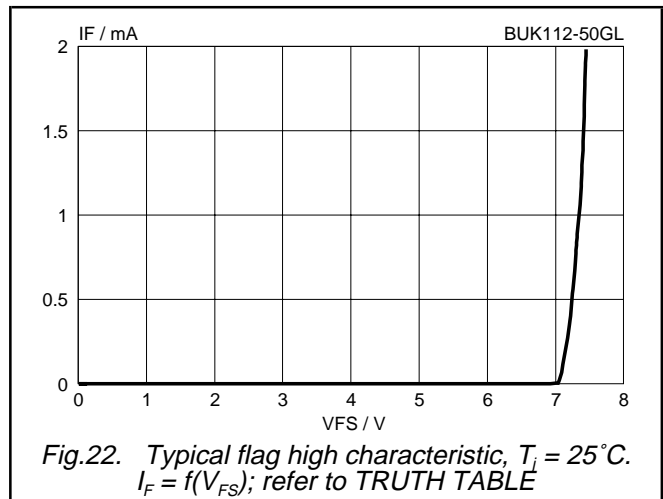
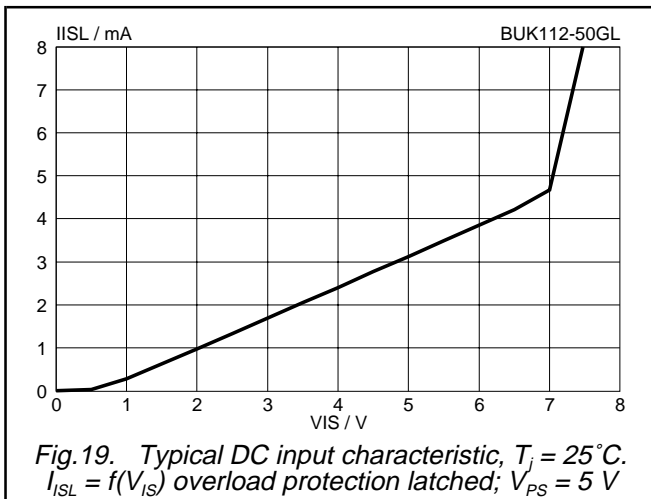
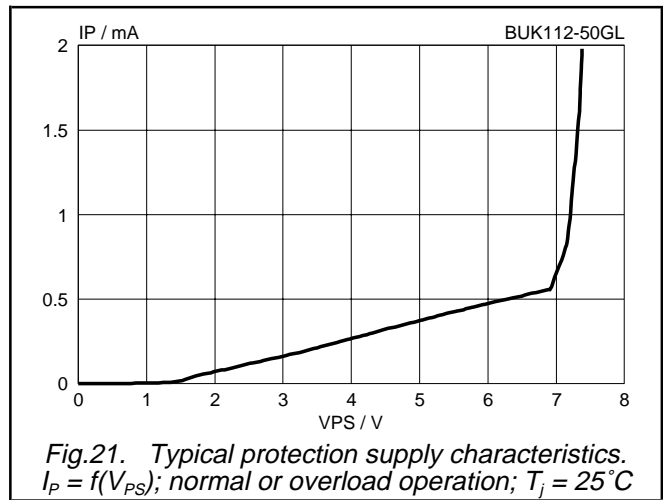
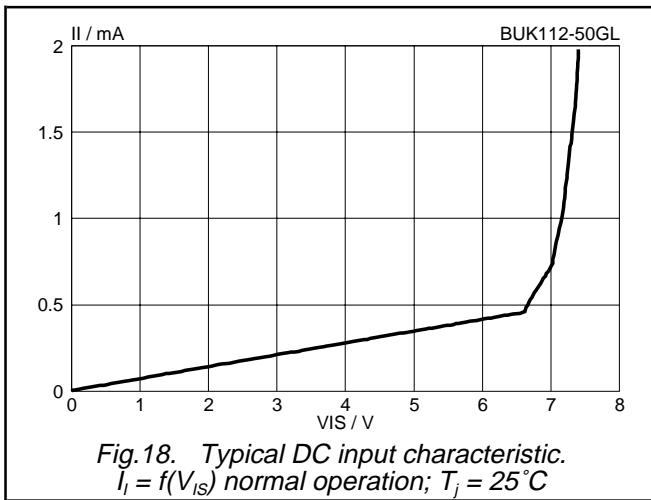

Fig.17. Typical overtemperature protection threshold.  
 $T_{j(TO)} = f(V_{PS})$ ;  $V_{IS} = 5\text{ V}$ ;  $I_D \geq 1\text{ A}$

PowerMOS transistor  
Logic level TOPFET

BUK112-50GL



PowerMOS transistor  
Logic level TOPFET

BUK112-50GL

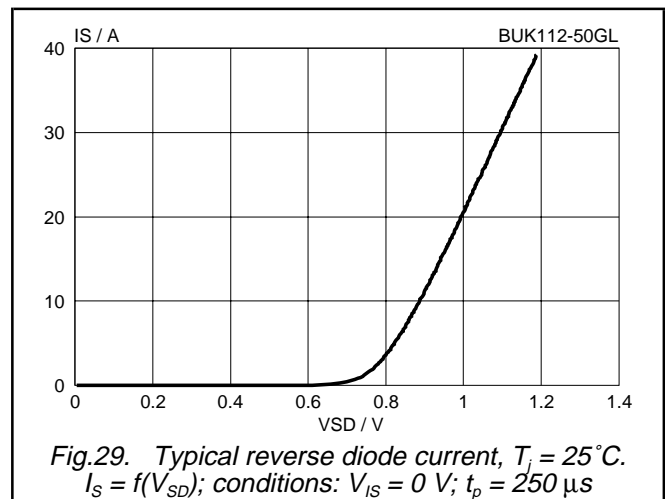
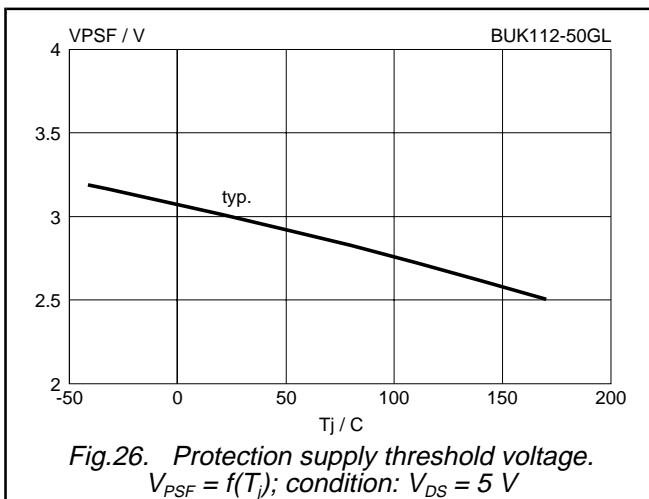
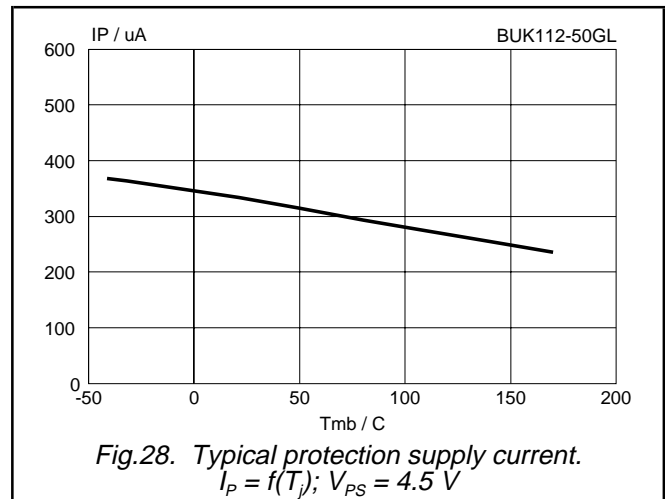
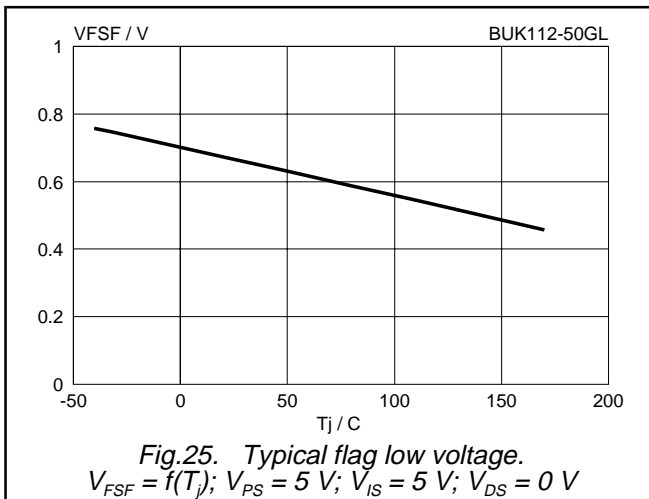
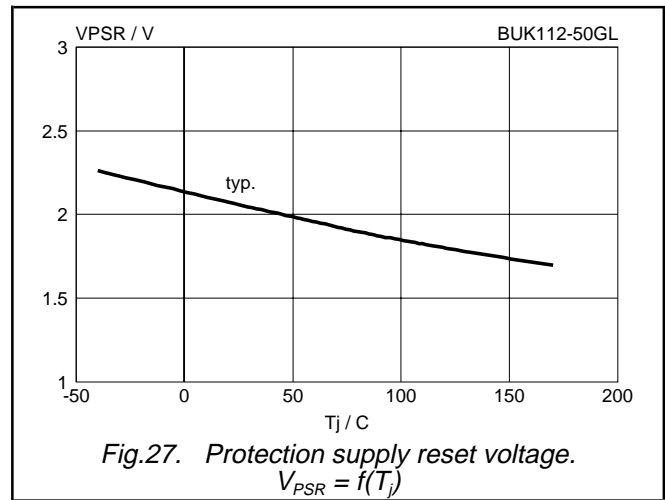
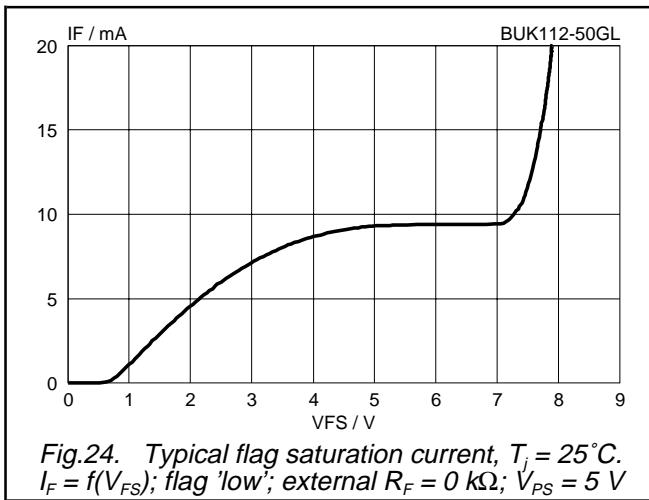

PowerMOS transistor  
Logic level TOPFET

BUK112-50GL

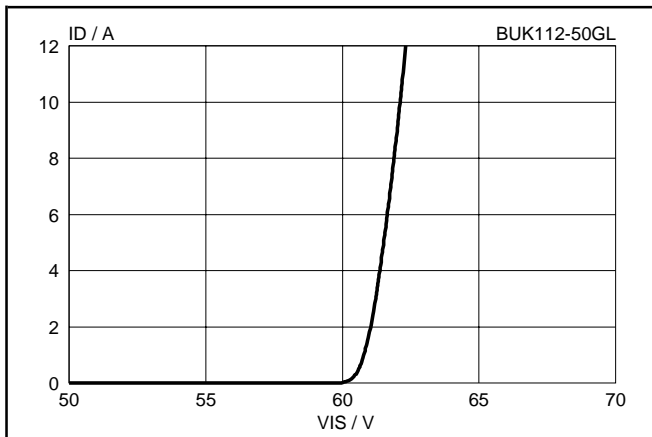

Fig.30. Typical clamping characteristics, 25°C.  
 $I_D = f(V_{DS})$ ; conditions:  $V_{IS} = 0\text{ V}$ ;  $t_p \leq 50\ \mu\text{s}$

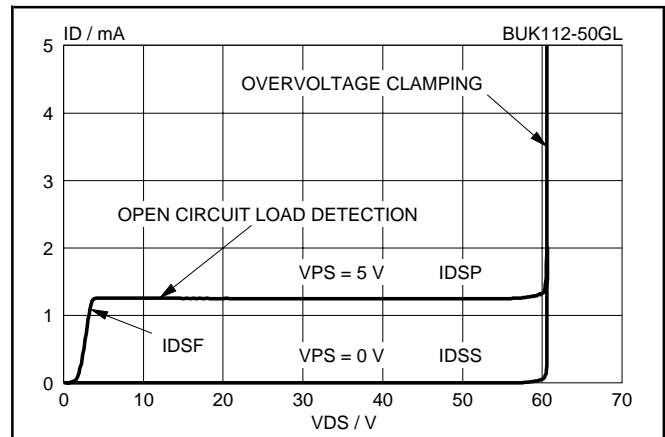

Fig.33. Typical off-state characteristics,  $T_j = 25^\circ\text{C}$ .  
 $I_D = f(V_{DS})$ ;  $V_{IS} = 0\text{ V}$ ; parameter  $V_{PS}$

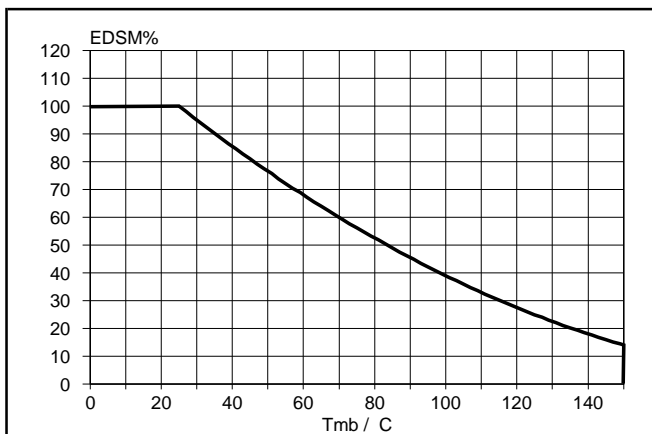

Fig.31. Normalised limiting clamping energy.  
 $E_{DSM}\% = f(T_{mb})$ ; conditions:  $I_D = 6\text{ A}$

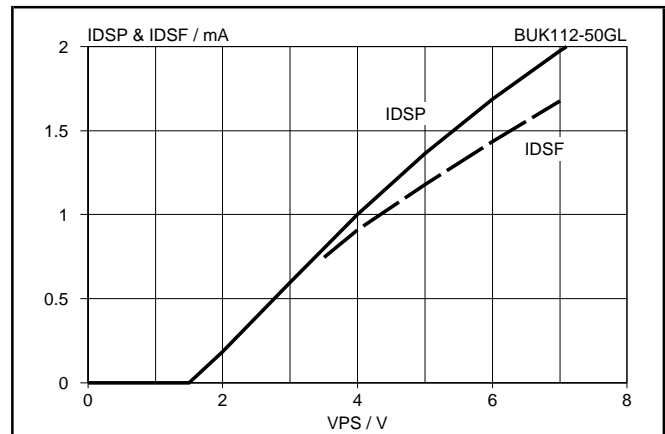

Fig.34. Typical open circuit load detect currents.  
 $I_{DSP} \text{ \& \ } I_{DSF} = f(V_{PS})$ ;  $V_{IS} = 0\text{ V}$ ;  $V_{DS} \geq 5\text{ V}$ ;  $T_j = 25^\circ\text{C}$

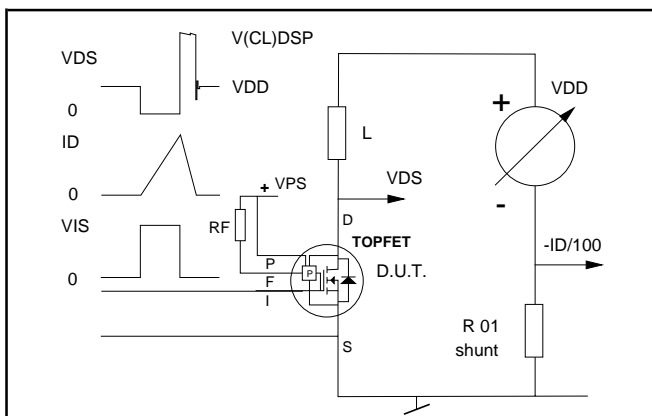

Fig.32. Clamping energy test circuit.  
 $E_{DSM} = 0.5 \cdot L I_D^2 \cdot V_{(CL)DSS} / (V_{(CL)DSS} - V_{DD})$

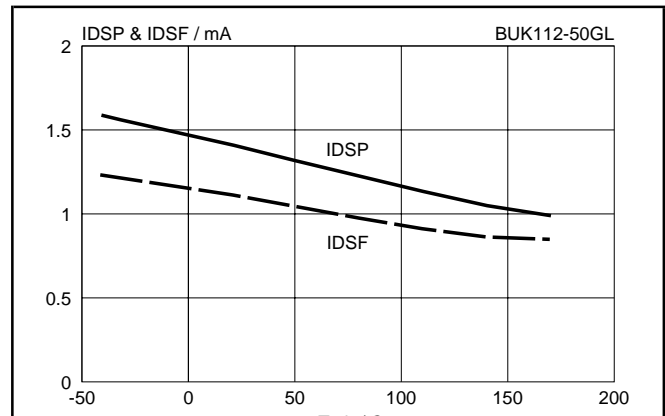
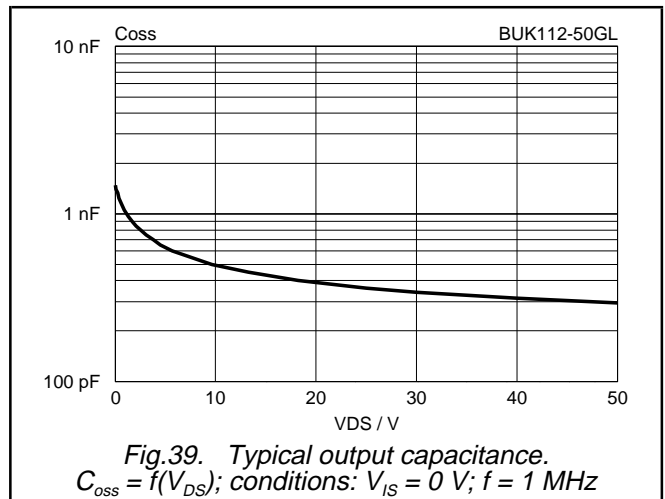
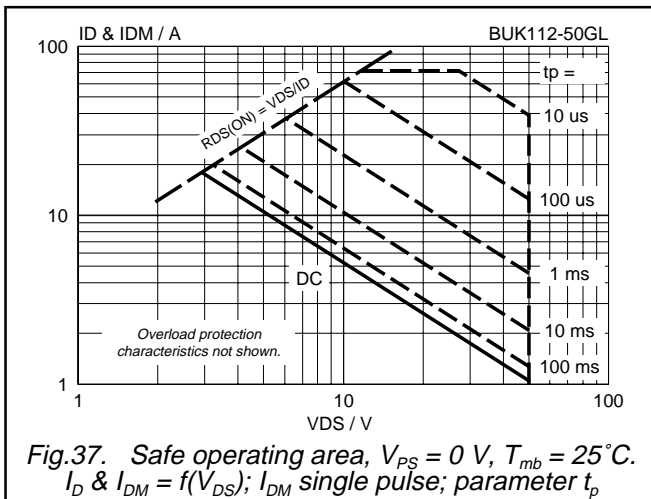
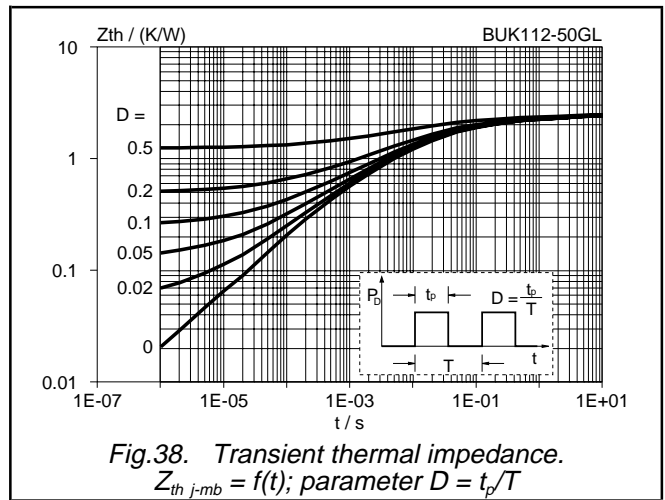
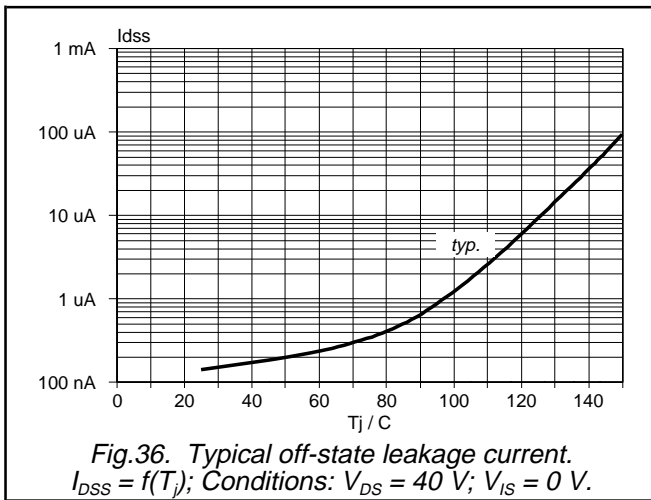

Fig.35. Typical open circuit load detect currents.  
 $I_{DSP} \text{ \& \ } I_{DSF} = f(T_j)$ ;  $V_{PS} = 5\text{ V}$ ;  $V_{IS} = 0\text{ V}$

PowerMOS transistor  
Logic level TOPFET

BUK112-50GL



PowerMOS transistor  
Logic level TOPFET

BUK112-50GL

APPLICATION INFORMATION

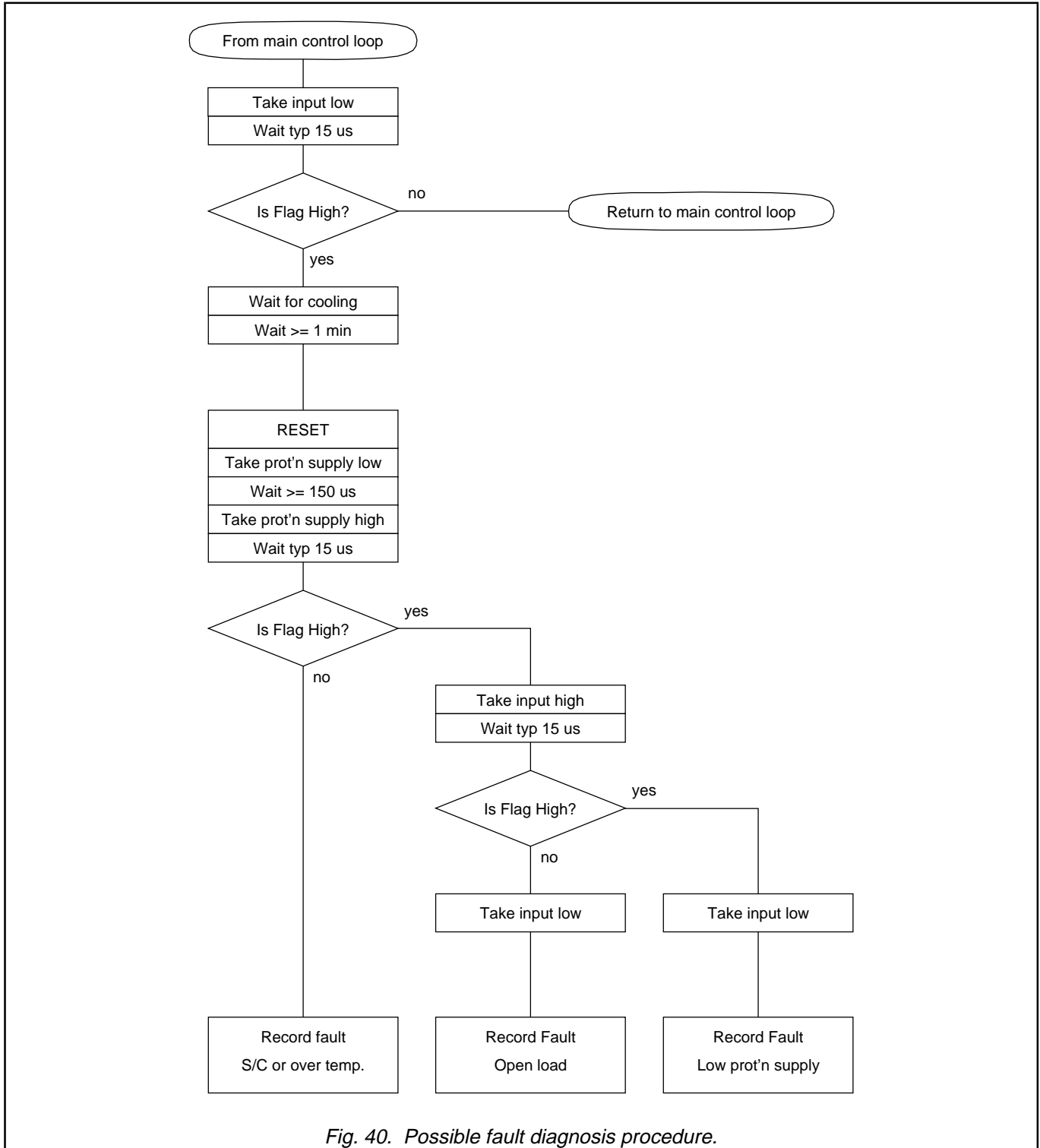
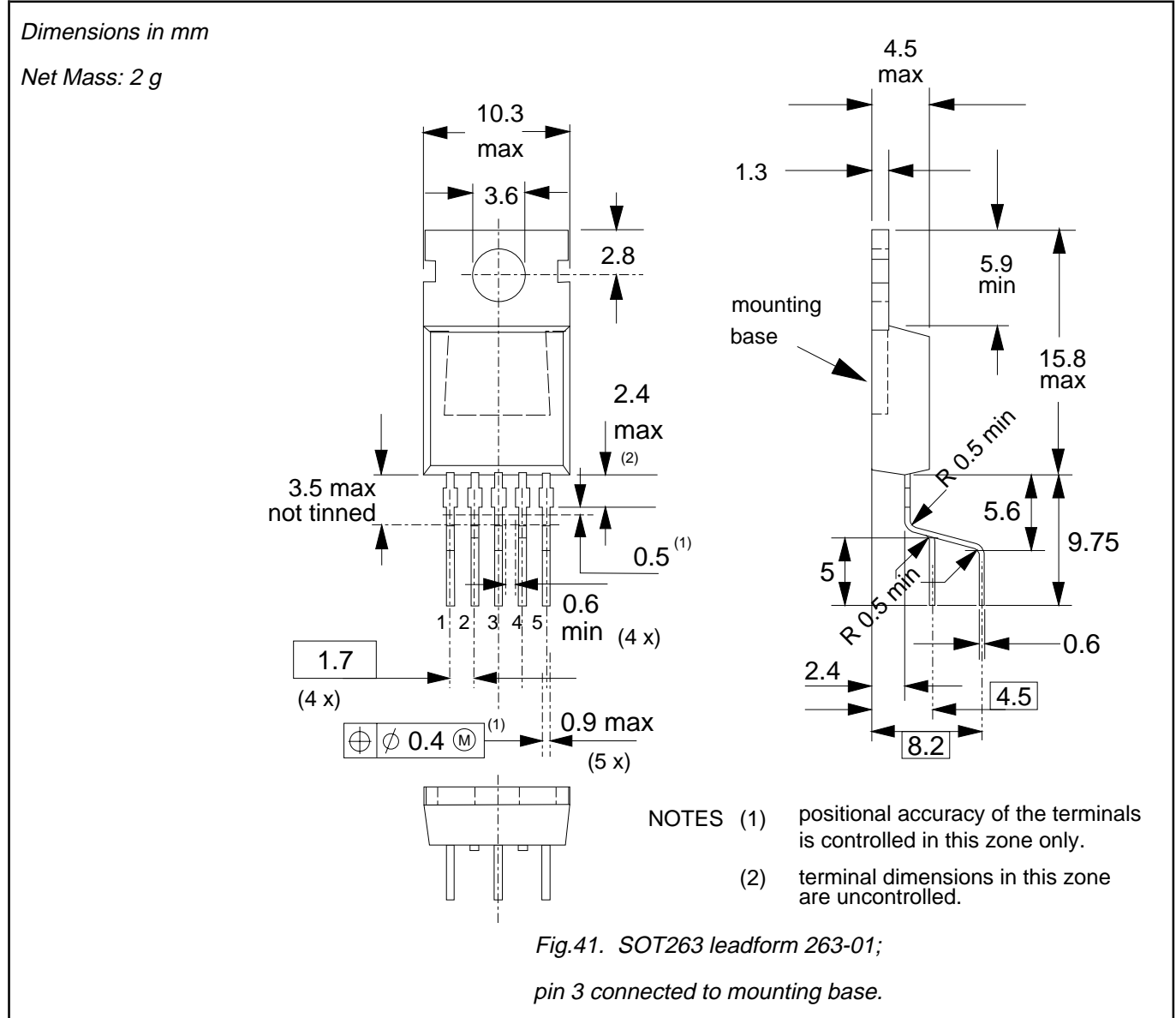

Fig. 40. Possible fault diagnosis procedure.

PowerMOS transistor  
Logic level TOPFET

BUK112-50GL

**MECHANICAL DATA**



**Note**

1. Refer to mounting instructions for TO220 envelopes.
2. Epoxy meets UL94 V0 at 1/8".

---

**PowerMOS transistor**  
**Logic level TOPFET**

---

**BUK112-50GL**

---

**DEFINITIONS**

<b>Data sheet status</b>	
Objective specification	This data sheet contains target or goal specifications for product development.
Preliminary specification	This data sheet contains preliminary data; supplementary data may be published later.
Product specification	This data sheet contains final product specifications.
<b>Limiting values</b>	
Limiting values are given in accordance with the Absolute Maximum Rating System (IEC 134). Stress above one or more of the limiting values may cause permanent damage to the device. These are stress ratings only and operation of the device at these or at any other conditions above those given in the Characteristics sections of this specification is not implied. Exposure to limiting values for extended periods may affect device reliability.	
<b>Application information</b>	
Where application information is given, it is advisory and does not form part of the specification.	
© Philips Electronics N.V. 1996	
All rights are reserved. Reproduction in whole or in part is prohibited without the prior written consent of the copyright owner.	
The information presented in this document does not form part of any quotation or contract, it is believed to be accurate and reliable and may be changed without notice. No liability will be accepted by the publisher for any consequence of its use. Publication thereof does not convey nor imply any license under patent or other industrial or intellectual property rights.	

**LIFE SUPPORT APPLICATIONS**

These products are not designed for use in life support appliances, devices or systems where malfunction of these products can be reasonably expected to result in personal injury. Philips customers using or selling these products for use in such applications do so at their own risk and agree to fully indemnify Philips for any damages resulting from such improper use or sale.